

PINK PROVIDES:

- 1 Tidal Wave Fabric
- 1 Set of 6 Curved Metals (Base)
- 1 Set of 8 Curved Metals (Top)
- 2 Sets of 3 Straight Metals (Sides)
- 2 Sets of 3 Shock Corded Curved Metals (Central Supports) Extra Pop Buttons

YOU PROVIDE:

- 2 Ladders, 8' min
- Site Plan/Event Layout
- Four Person Team
- Plastic Drop Cloth
- Gloves
- Sewing Kit

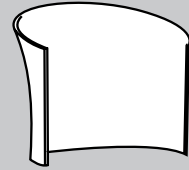

Additional Support Please Call:
212-253-6666 or
After Hours: 646-853-3900

Metals are labeled for easy assembly. Simply match the corresponding parts, depress the button, and slide together.

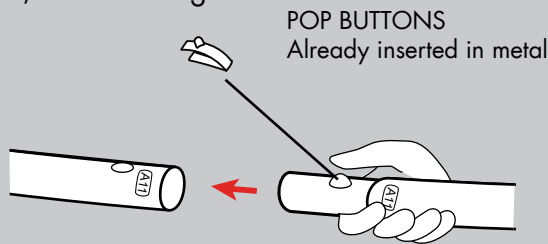

1. Join together the set of 6 curved pieces to create the base.

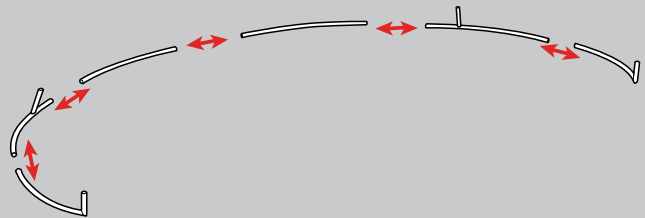

Prior to assembly, lay out drop cloth in designated work location. Before working with fabric, wash hands or put on gloves.

2. Join together the set of 8 curved pieces to create the top piece.

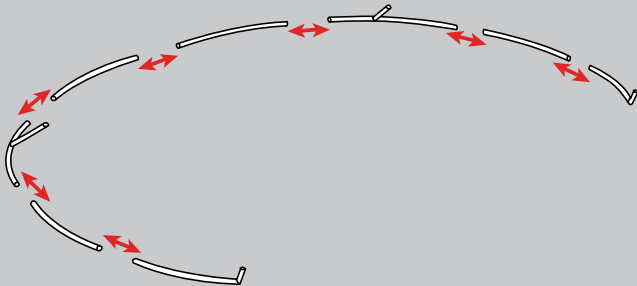

3. Join together the remaining straight sets (A) and central supports (B.)

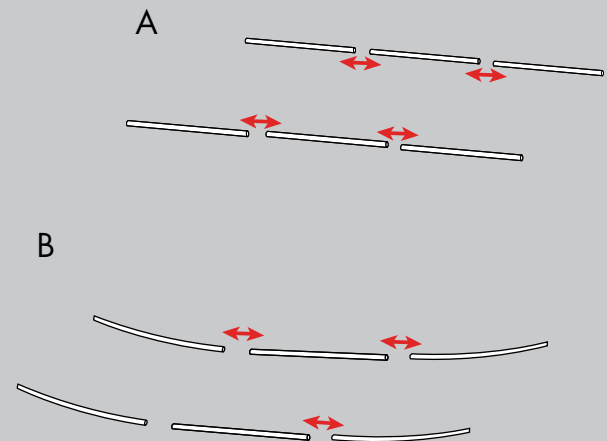

Any and all rights (including, without limitation, copyright, design patent, use patent and trademark) in and to all designs, concepts, renderings, or graphics (collectively, "Design") represented in this document were created by Moss Inc. and remain the sole and exclusive property of Moss Inc. Use of any such Design by the recipient without required purchase is strictly prohibited. ©2010

4. Before attaching any groups of pieces, lay out as shown below. The smaller curved piece will be the bottom of the Tidal Wave.

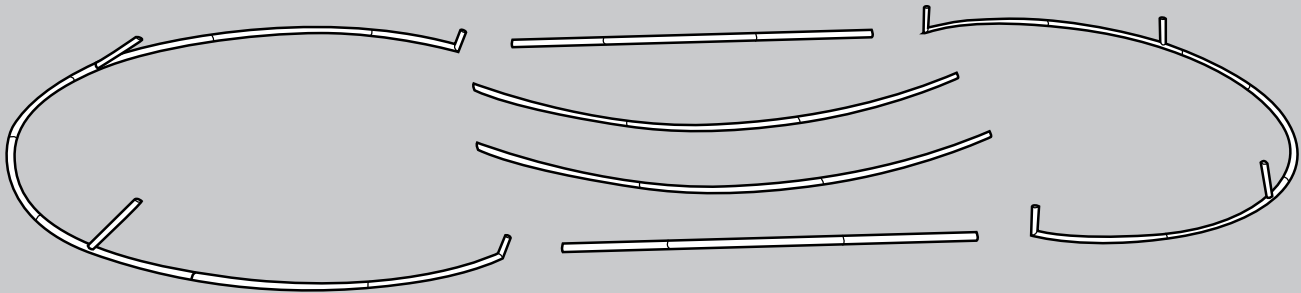

5. Detach the 4 ends of the curved pieces and attach them to the corresponding base supports.

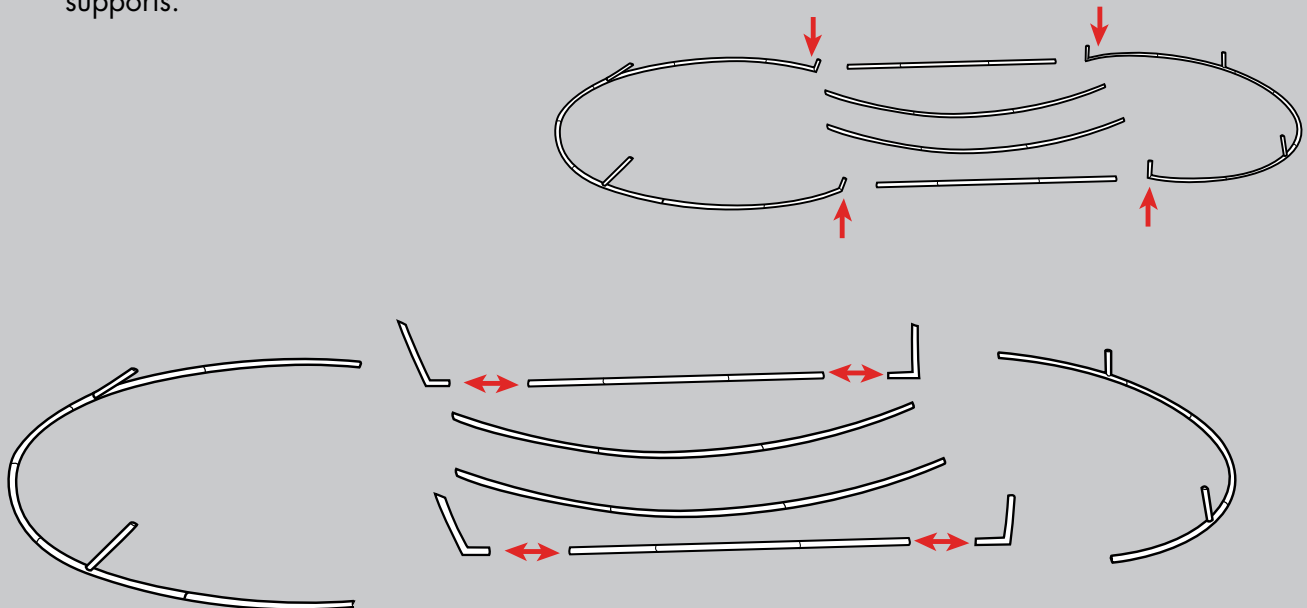

Any and all rights (including, without limitation, copyright, design patent, use patent and trademark) in and to all designs, concepts, renderings, or graphics (collectively, "Design") represented in this document were created by Moss Inc. and remain the sole and exclusive property of Moss Inc. Use of any such Design by the recipient without required purchase is strictly prohibited. ©2010

6. Stand the two curved pieces. Have one person supporting each one until both curved spines are attached.

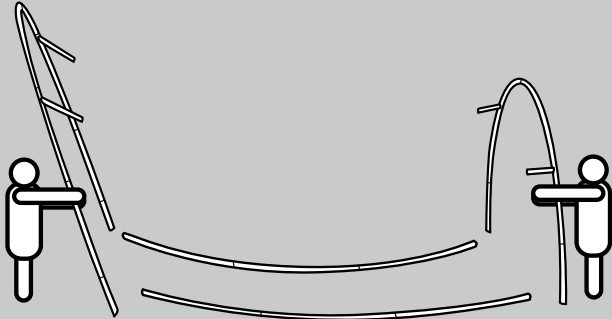

7. Attach the spines one at a time. Allowing them to hang free will damage the metals.

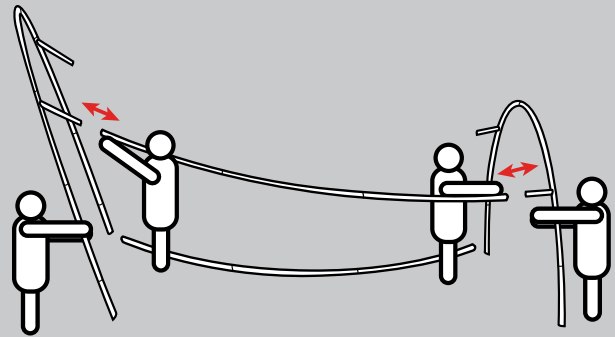

8. After attaching both spines, have each person stand at a corner of the structure. This is important as step 9 must be completely with everyone working simultaneously.

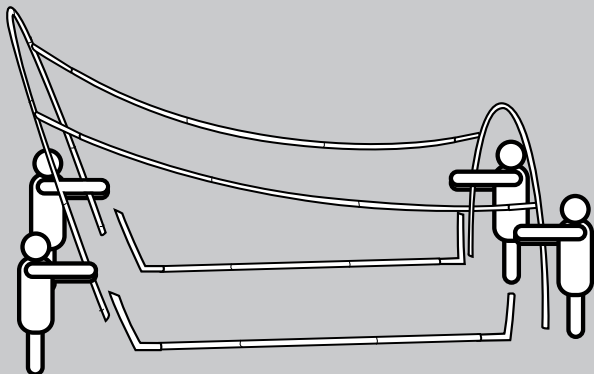

9. Lift the structure and align with the base. Once all pieces are connected, the metal structure is complete.

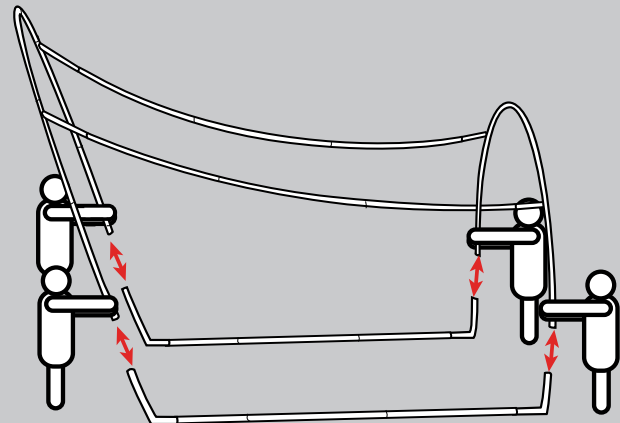

Any and all rights (including, without limitation, copyright, design patent, use patent and trademark) in and to all designs, concepts, renderings, or graphics (collectively, "Design") represented in this document were created by Moss Inc. and remain the sole and exclusive property of Moss Inc. Use of any such Design by the recipient without required purchase is strictly prohibited. ©2010

10. Locate the fabric and identify the convex and concave sides. It is important that the convex side is on the top/outside of the wall. The concave side will be on the inside.

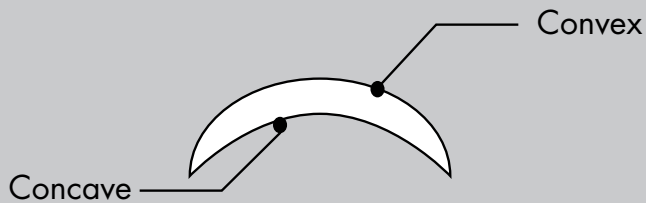

11. Slide the fabric on to the larger end first. Have two people tilt the structure by lifting the shorter end into the air, so that the larger end can be reached.

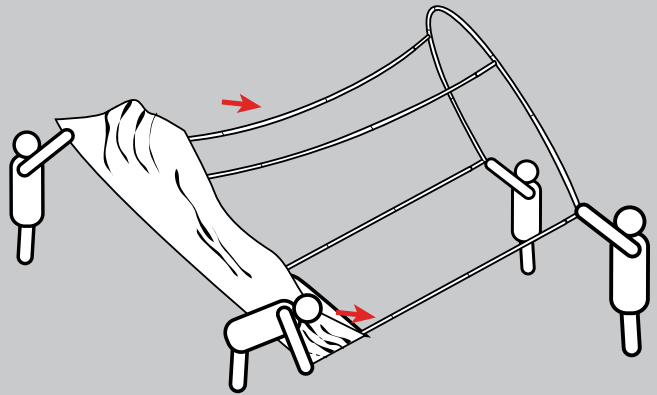

12. Continue sliding the fabric over the frame. Please note that the corners have doubled fabric to prevent wear. The zipper runs along the metal curve of the base.

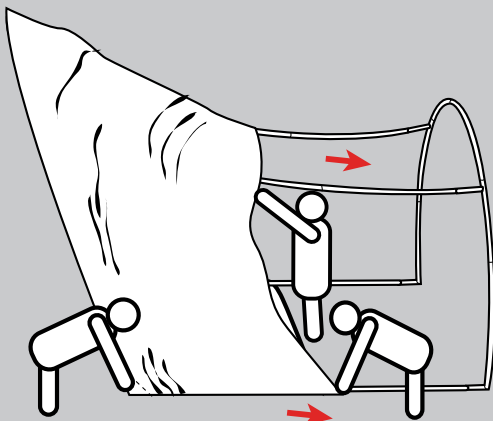

13. Have three people pull the fabric over the metal while the fourth zips it closed. If needed, lift the larger end up to tilt the structure and reach the high point of the smaller side.

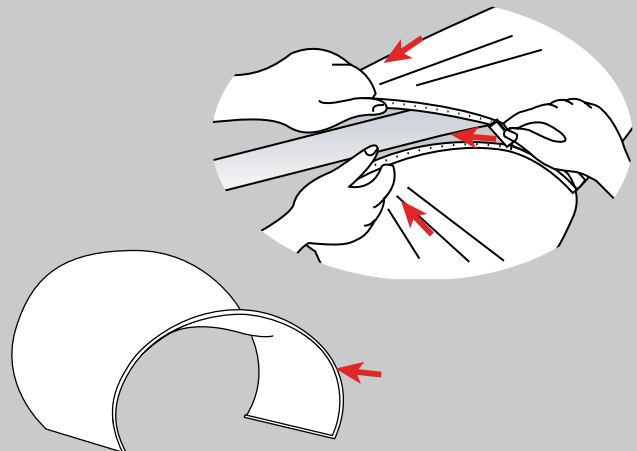

Any and all rights (including, without limitation, copyright, design patent, use patent and trademark) in and to all designs, concepts, renderings, or graphics (collectively, "Design") represented in this document were created by Moss Inc. and remain the sole and exclusive property of Moss Inc. Use of any such Design by the recipient without required purchase is strictly prohibited. ©2010

14. Once zipped, adjust and align seams as needed. To move the structure, make sure there is a person lifting at every corner. Stand the Tidal Wave in desired location.

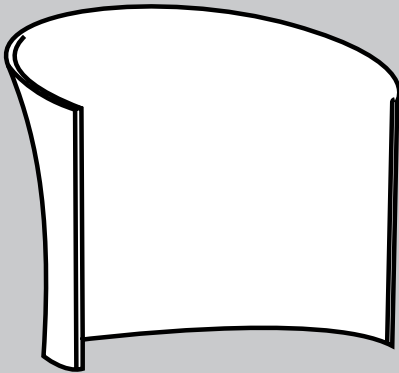

Trouble Shooting:

- If zipper gets stuck:
 - * DO NOT use force;
 - * Try to locate what is catching.
- If "tooth" in zipper is bent:
 - * Move into place with thumbs or press gently with pliers while zipping.
- If "tooth" in zipper is missing:
 - * Align the zipper as straight as possible and zip quickly and smoothly over the problem area.

Final Notes:

Metals:

After use, dismantle. Each metal is labeled, so please place back in corresponding labeled bag. If possible, zip-tie pieces together.

Under NO circumstances should the metals be taped to one another.

Fabric

Each fabric is labeled on the Pink Inc. tag and should be placed back in the corresponding labeled bag.

Any and all rights (including, without limitation, copyright, design patent, use patent and trademark) in and to all designs, concepts, renderings, or graphics (collectively, "Design") represented in this document were created by Moss Inc. and remain the sole and exclusive property of Moss Inc. Use of any such Design by the recipient without required purchase is strictly prohibited. ©2010