

**PINK PROVIDES:**

- 2 Black Base Covers
- 2 Pole Covers
- 1 Cross Bar Cover
- 15 Pre-Piped Orbit Fabrics
- 15 4' Fiberglass Rods with white end caps
- Extra white end caps
- Extra rods

**YOU PROVIDE:**

- 2 12' Auto-Poles
- 2 Base Plates
- 1 10' Cross Bar
- Two Person Team
- 4 Sandbags
- Zip-Ties
- Shears or Diagonal Cutters

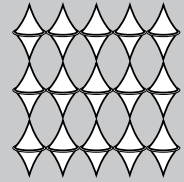

Additional Support Please Call:  
212-253-6666 or  
After Hours: 646-853-3900

If base plate is not assembled, assemble with nipple. Place near final location.

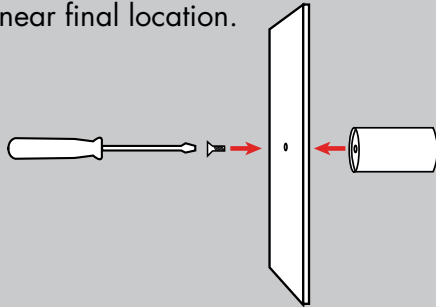

1. Place the base cover onto the base plate as indicated below.

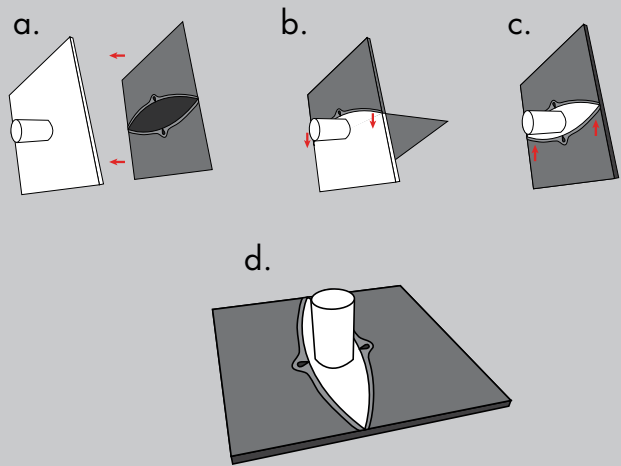

Please note: Heights and width shown are for a standard 10' X 10' setup.

Please refer to the product instruction page for correct dimensions.

2. Preset the auto-poles to the correct height. Then slide the pole covers over the auto-poles.

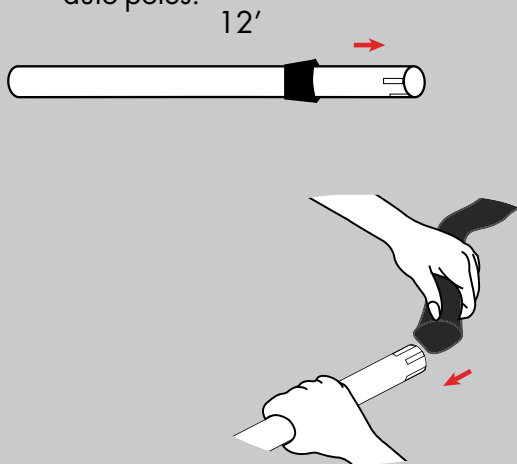

3. Lay the auto-poles near the assembled base plates. The auto-poles should be preset to the correct height and covered.

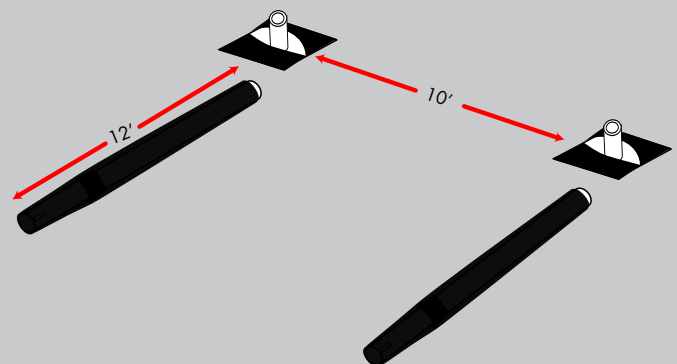

Any and all rights (including, without limitation, copyright, design patent, use patent and trademark) in and to all designs, concepts, renderings, or graphics (collectively, "Design") represented in this document were created by Moss Inc. and remain the sole and exclusive property of Moss Inc. Use of any such Design by the recipient without required purchase is strictly prohibited. ©2010

4. Depending on available space, preset the cross bar to the correct width. Then slide the cross bar cover over the cross bar. 10' will allow the orbits to be fully stretched.

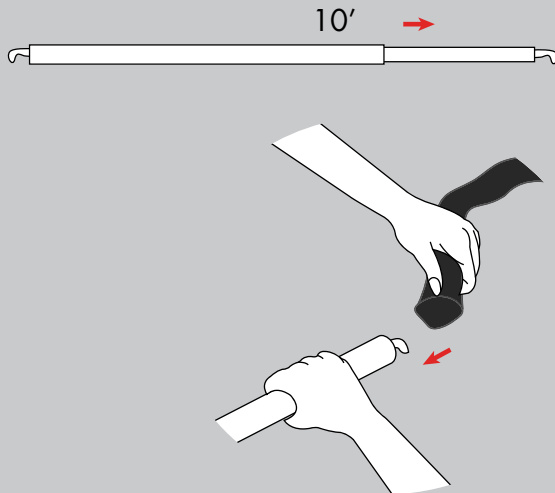

5. The pole has notches and slots. It is important to always work with the slots when using Pink Inc. products. Slide the cross bar into the slots on each side.

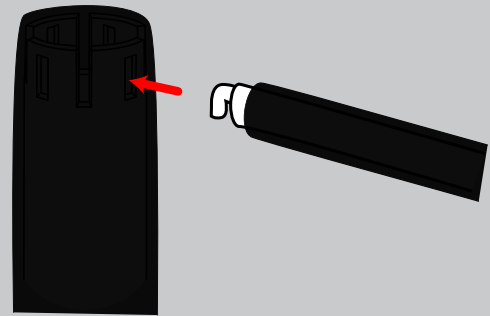

6. After sliding the cross bars into the slots, push down to set in place.

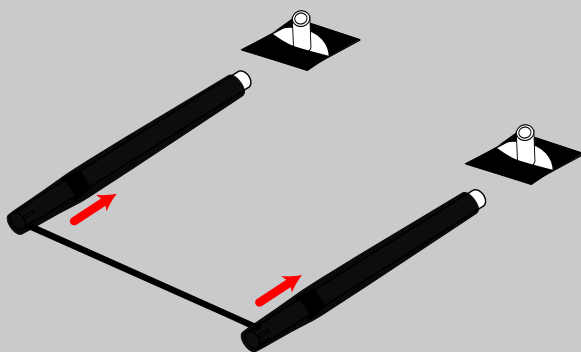

7. Lay out the drop cloth and put on gloves. To pipe, locate a 4' fiberglass rod and insert it into the slit in the seam near the top of the fabric.

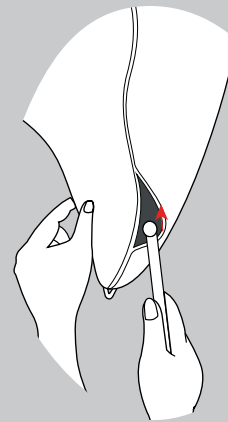

The slit may be hard to find as it is meant to be "invisible."

Any and all rights (including, without limitation, copyright, design patent, use patent and trademark) in and to all designs, concepts, renderings, or graphics (collectively, "Design") represented in this document were created by Moss Inc. and remain the sole and exclusive property of Moss Inc. Use of any such Design by the recipient without required purchase is strictly prohibited. ©2010

8. Stretch the rod between the top and bottom points of the fabric. Repeat steps 7 - 8 until all Orbits are piped.

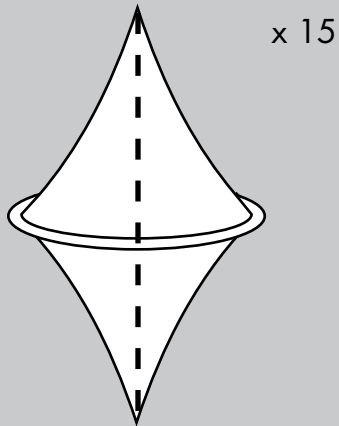

9. Loosely attach the top five Orbits to the cross bar using zip-ties. It is important that these points are not tightened as they may need to be shifted.

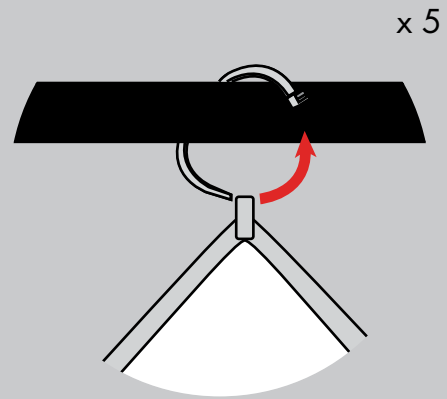

10. Connect the Orbits to one another using zip-ties through the loops on the Orbit "rings." Tighten zip-ties completely.

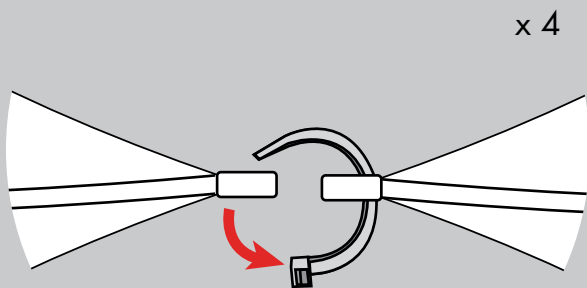

11. Straighten the Surround so it is positioned evenly between the poles. Tighten the zip-ties at the top and snip tails.

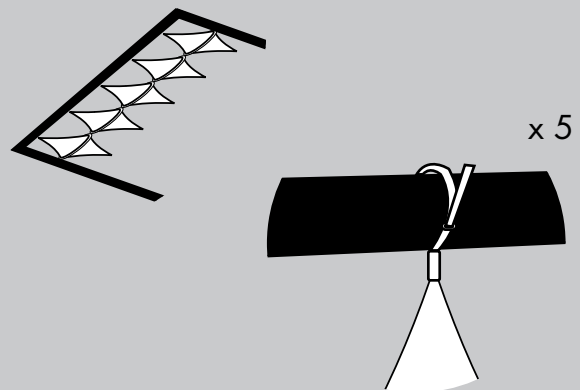

Any and all rights (including, without limitation, copyright, design patent, use patent and trademark) in and to all designs, concepts, renderings, or graphics (collectively, "Design") represented in this document were created by Moss Inc. and remain the sole and exclusive property of Moss Inc. Use of any such Design by the recipient without required purchase is strictly prohibited. ©2010

12. Stretch the side points to the poles, attach with zip-ties, and tighten. If using small zip-ties, you may need two in order to go around the pole completely.

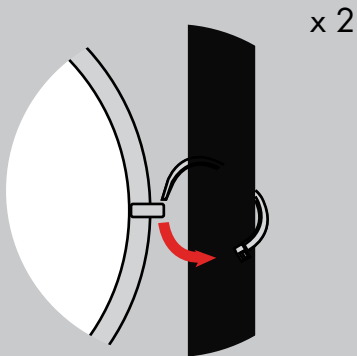

13. Repeat steps 9 - 12 with the remaining Orbits. The second row of orbits gets tied to the first row using zip-ties through the loops of the Orbits. After attaching all three rows and tightening the zip-ties, go back and snip all tails tight to the box.

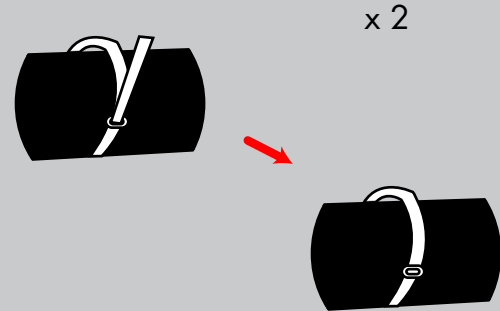

Do not forget to snip tails on ties between the Orbits. Loose tails will rip the fabric.

14. Using two people, one per pole, lift the Orbit Surround onto the preset base plates.

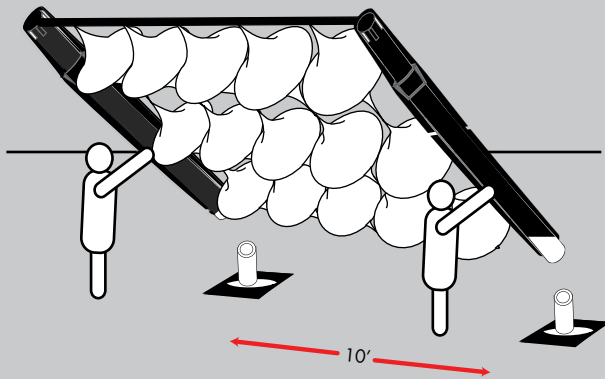

15. The bottom of the Surround hangs free.

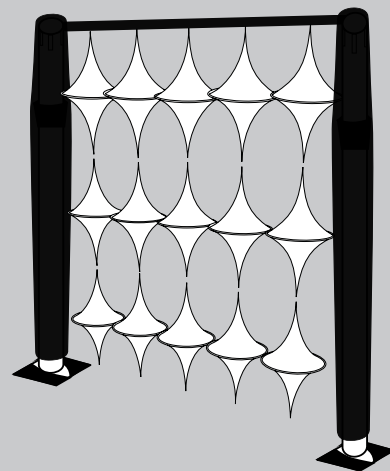

Any and all rights (including, without limitation, copyright, design patent, use patent and trademark) in and to all designs, concepts, renderings, or graphics (collectively, "Design") represented in this document were created by Moss Inc. and remain the sole and exclusive property of Moss Inc. Use of any such Design by the recipient without required purchase is strictly prohibited. ©2010

Fiberglass precautions:

- \* Do not run hand along rod;
  - \* Wear gloves;
  - \* Handle gently to avoid breaking rod.
- If you get a fiberglass splinter:
- \* Wash hands with soap and water;
  - \* Treat as a splinter.
- If a fiberglass rod breaks:
- \* Do not re-use; throw away;
  - \* Replace with extra provided.

Any and all rights (including, without limitation, copyright, design patent, use patent and trademark) in and to all designs, concepts, renderings, or graphics (collectively, "Design") represented in this document were created by Moss Inc. and remain the sole and exclusive property of Moss Inc. Use of any such Design by the recipient without required purchase is strictly prohibited. ©2010