

PINK PROVIDES:

- 1 Set of Trigon Metals
- 1 Trigon Fabric
- Extra Pop Buttons

YOU PROVIDE:

- Site Plan/Event Layout
- Two Person Team
- Gloves
- Sewing Kit
- Plastic Drop Cloth
- Allen Key Set

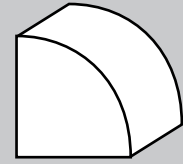

Additional Support Please Call:
212-253-6666 or
After Hours: 646-853-3900

Metals are labeled for easy assembly. Simply match the corresponding parts, depress the button, and slide together.

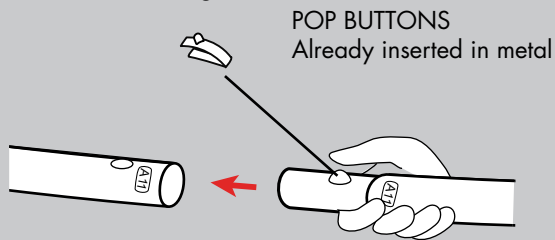

1. Join the straight pieces that create one of the surfaces first.

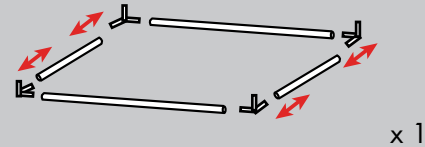

Prior to assembly, lay out drop cloth in designated work location. Before working with fabric, wash hands or put on gloves.

2. Attach the rest of the straight pieces to create the second flat surface.

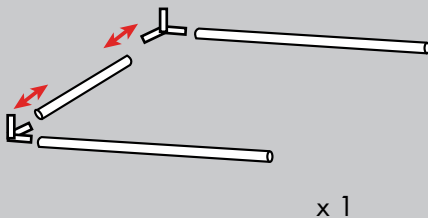

3. Attach the curved pieces from with the straight pieces from step 2.

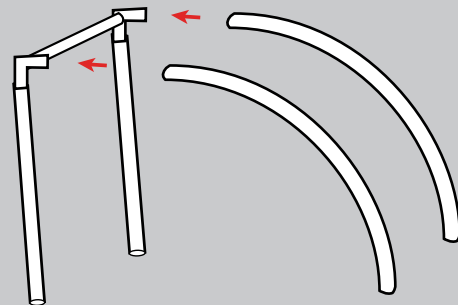

Any and all rights (including, without limitation, copyright, design patent, use patent and trademark) in and to all designs, concepts, renderings, or graphics (collectively, "Design") represented in this document were created by Moss Inc. and remain the sole and exclusive property of Moss Inc. Use of any such Design by the recipient without required purchase is strictly prohibited. ©2010

4. Set the piece from step 1 flat on the ground. Lift up the piece from step 4 and set onto the piece from step 1. Slide into place.

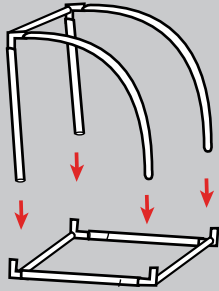

These will only slide together properly if all 4 pieces indicated are aligned prior to sliding into place.

5. Attach the support that goes between the curved sides of the Trigon.

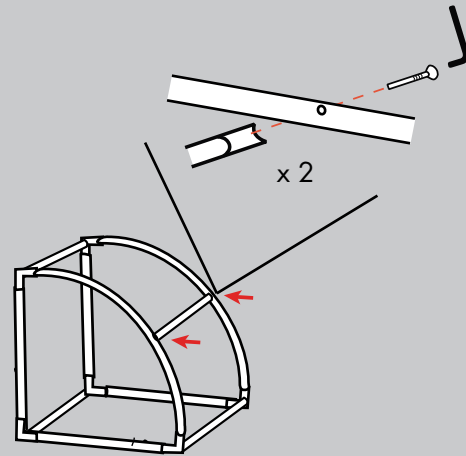

6. Locate the fabric. The zipper on the fabric will run along one side and then turn down another.

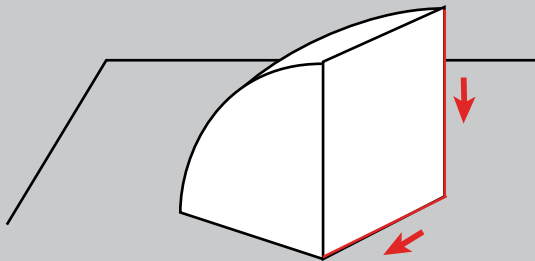

The piece is reversible and symmetrical, so it doesn't matter which side.

7. Find the end of the zipper and trace the seam back to the corner. Then place hand into the fabric, grasping the corner from the inside.

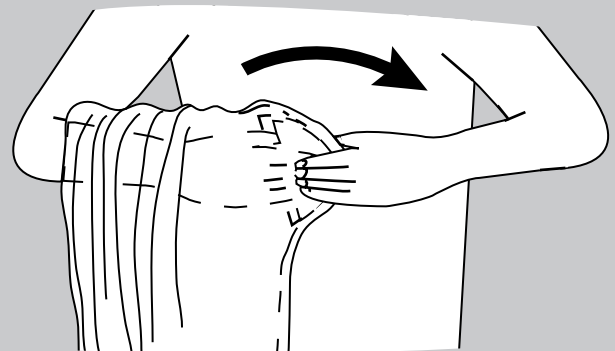

Any and all rights (including, without limitation, copyright, design patent, use patent and trademark) in and to all designs, concepts, renderings, or graphics (collectively, "Design") represented in this document were created by Moss Inc. and remain the sole and exclusive property of Moss Inc. Use of any such Design by the recipient without required purchase is strictly prohibited. ©2010

8. Continue holding each corner. Transfer the fabric from one arm to the other so it becomes inside-out.



9. Stretch the fabric over the entire piece.

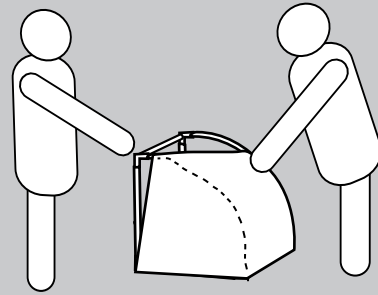

10. Have one person pull the fabric over the metal while the other one zips. The fabric is strong, so we encourage pulling hard!

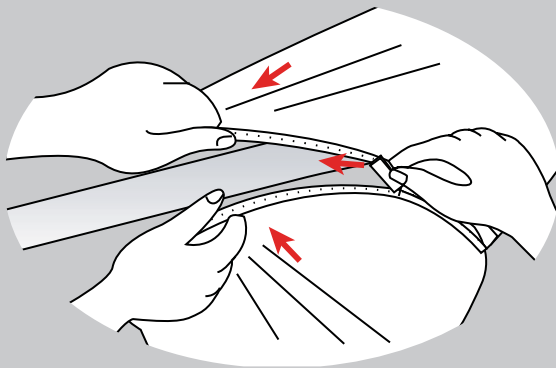

11. Once zipped, the Trigon is complete.

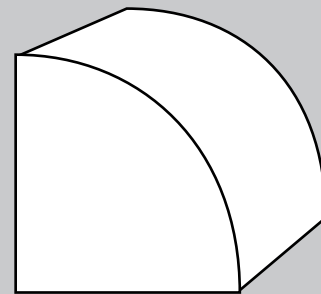

Any and all rights (including, without limitation, copyright, design patent, use patent and trademark) in and to all designs, concepts, renderings, or graphics (collectively, "Design") represented in this document were created by Moss Inc. and remain the sole and exclusive property of Moss Inc. Use of any such Design by the recipient without required purchase is strictly prohibited. ©2010

Final Note:

Metals:

After use, dismantle. Each metal is labeled; place back in the corresponding labeled bag. If possible, zip-tie pieces together.

Under NO circumstances should the metals be taped to one another.

Fabric:

Each fabric is labeled on the Pink Inc. tag and should be placed back in the corresponding labeled bag.

Any and all rights (including, without limitation, copyright, design patent, use patent and trademark) in and to all designs, concepts, renderings, or graphics (collectively, "Design") represented in this document were created by Moss Inc. and remain the sole and exclusive property of Moss Inc. Use of any such Design by the recipient without required purchase is strictly prohibited. ©2010